

Level Railing

Installation Guide

Top Rail

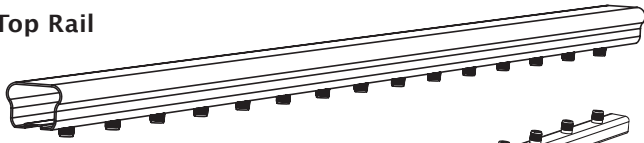

Bottom Rail

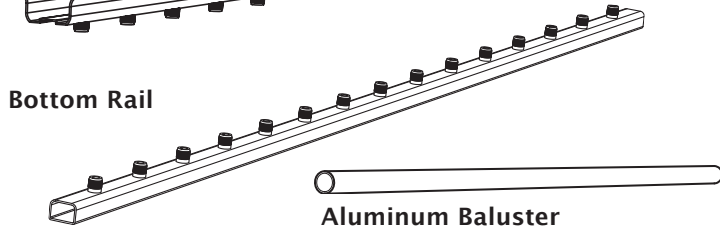

Aluminum Baluster



2x
Bottom
Bracket



1x
Rail
Support

Kit Includes:

- 1 – Top Rail (with Baluster Connectors installed)
- 1 – Bottom Rail (with Baluster Connectors installed)
- 2 – Bottom Rail Brackets (PTP/OTP) Level (with screws)
- 1 – Rail Support – Top/Deck Mount

Aluminum Balusters:

- 10 Balusters with 4' Kit
- 15 Balusters with 6' Kit
- 21 Balusters with 8' Kit

Top Rail Brackets sold separately

Before Starting the Installation

Review all local building codes. Wear proper safety equipment.

NOTE: always lay material on a clean, non-abrasive surface material (such as the box it came in) when cutting or assembling. This is a pre finish product and damage may occur.

STEP 1

Lay out post placement.

STEP 2

Determine size and surface post mount required.

3-1/2" Surface Post Mount for Post To Post (PTP) applications or 1-7/8" Surface or Side/Fascia Post Mount for Over The Post (OTP) applications.

Using Surface Post Mount:

Set post mount in place and mark four mounting holes. Pre-drill four holes for 5/16" mounting bolts (hardware not supplied).

Set post mount in place and install mounting bolts.

Check mount with level and shim if necessary (using metal or composite shims).

Slide post sleeve over post mount. Adjust height, if necessary, by cutting length of post to proper height (see manufacturer's specifications).

Using Side/Fascia Post Mount:

Insert post mount inside 1-7/8" post sleeve. Align pre-drilled holes in post mount with bottom of post sleeve.

NOTE: 1-7/8" post layout is 8" end to mount on fascia, 2" gap between deck surface and bottom of bottom rail and balance of post for 36" and 42" height railing.

Set post in place, mark and drill for 5/16" mounting bolts (hardware not supplied).

Set post in place, install mounting hardware. Check post with level and shim if necessary (using metal shims).

STEP 1

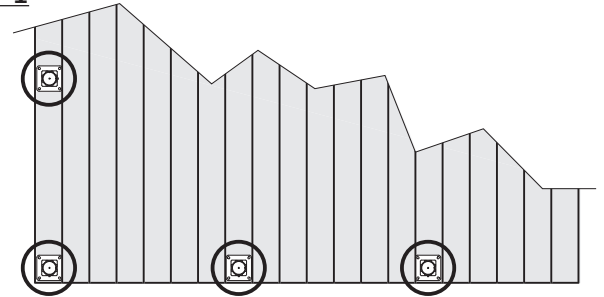

STEP 2

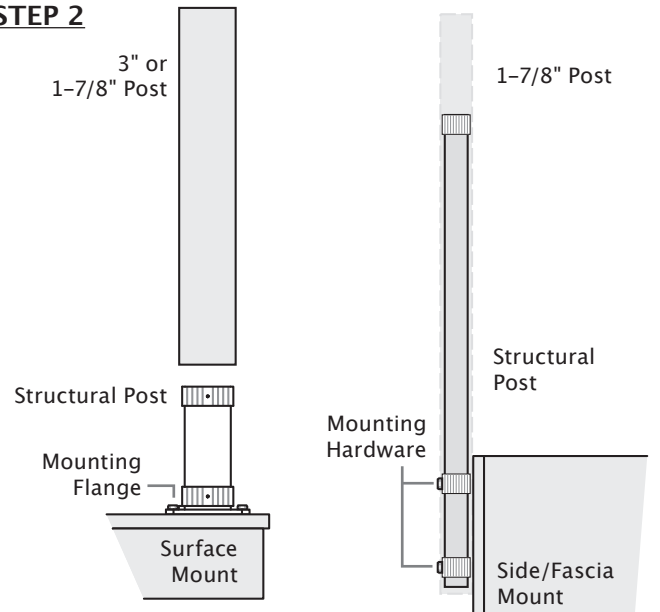

STEP 3

Measure distance from post to post and deduct 3/8" from each end of rail.

Measure bottom rail ensuring **equal and maximum spacing** from end of rail to the first baluster on both ends of the bottom rail. Cut bottom rail with a metal cutting blade (check manufacturer's specs for proper blade).

Repeat previous steps when measuring and cutting the top rail.

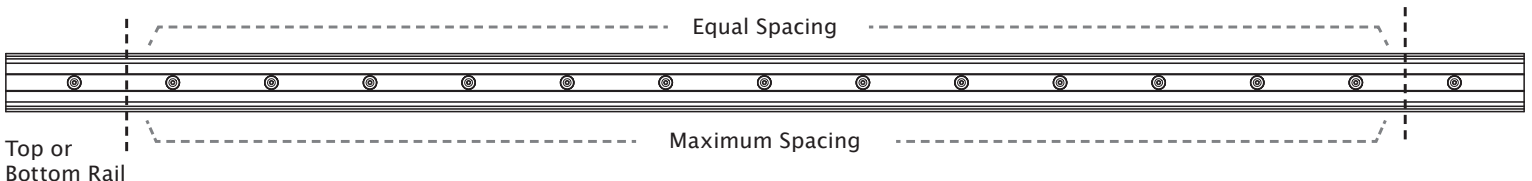

Level Railing

Installation Guide (continued)

STEP 4

Method 1:

Insert balusters onto the baluster connectors that are provided attached to the bottom rail.
Insert first two balusters from one end of section onto the baluster connectors attached to the top rail.
Install a strap (not included) on this end.
Continue working down the length of the rail inserting the balusters onto the top rail.
When finished, install strap on other side.

OR

Method 2:

Insert balusters onto the baluster connectors that are provided attached to the bottom rail. Lay rail section on a flat surface and use a block (or board) under balusters to line up with baluster connectors on the top rail.
Insert balusters onto the baluster connectors attached to the top rail. Install straps (not included) on both ends.

The rail support surface mount (foot block) provided is designed for a maximum 3" of clearance between the bottom rail and the walking surface. TIP: If a smaller clearance is required, the rail support can be carefully cut by mounting to scrap wood and cutting with a mitre saw. (See Cutting Rail Support notes)

Install rail support to the bottom rail in the center point of the section.

Drill a 3/16" weep hole under bottom rail at two locations mid-point between rail support and each end of the section.

STEP 5

Using wood scrap, cut two spacer blocks that are the same height as the rail support. For example: using the maximum desired rail support clearance of 3", the blocks would be the same height. Place each block approximately 12" from each post. (See Step 5a illustration)

Slide top and bottom mounting brackets on ends of rail section. (See Step 5b illustration)

Set rail section between posts, resting on blocks, with mounting brackets centered on posts.

Install Self-drilling Stainless Steel screws through mounting brackets into posts while maintaining the rail in a level position.

Install Self-tapping Stainless Steel screws up through the bottom of the TOP mounting brackets into the rail.

Remove straps and spacer blocks.

Install post caps and post base trim.

CUTTING RAIL SUPPORT

Place Rail Support - Surface Mount face down on scrap wood.

Screw into wood flush against back stop.

Cut, remove from scrap wood.

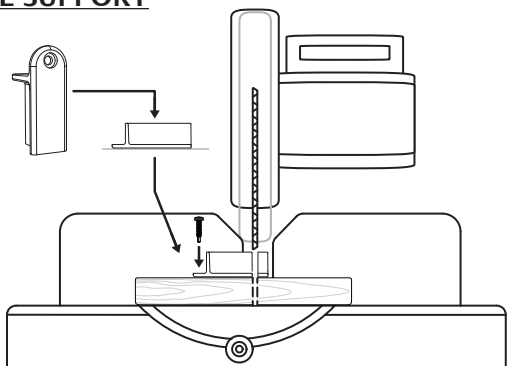

BRACKET-SPECIFIC NOTES

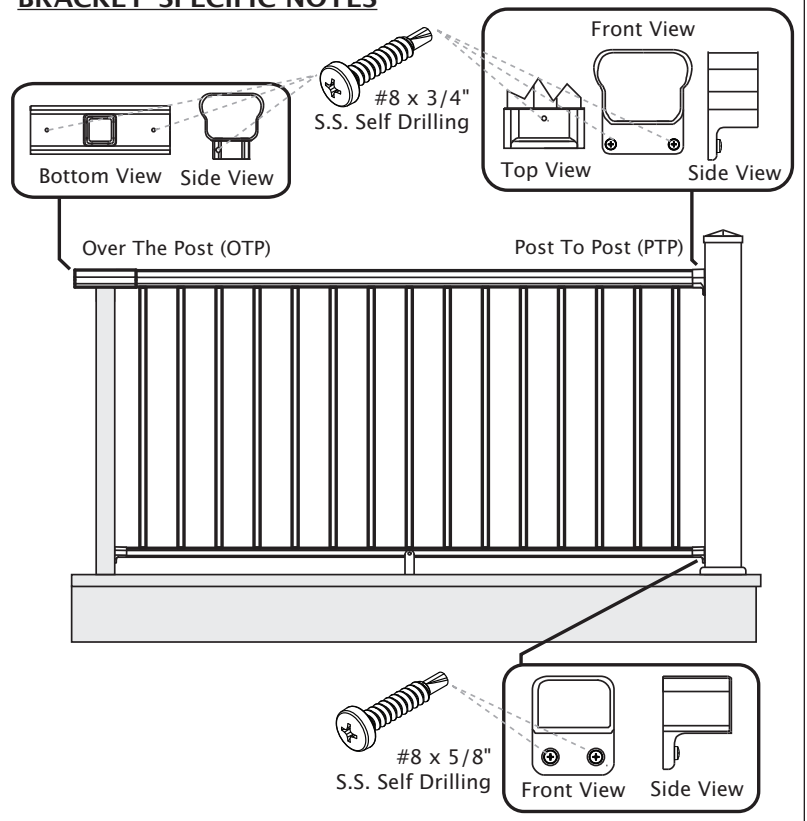

STEP 5B

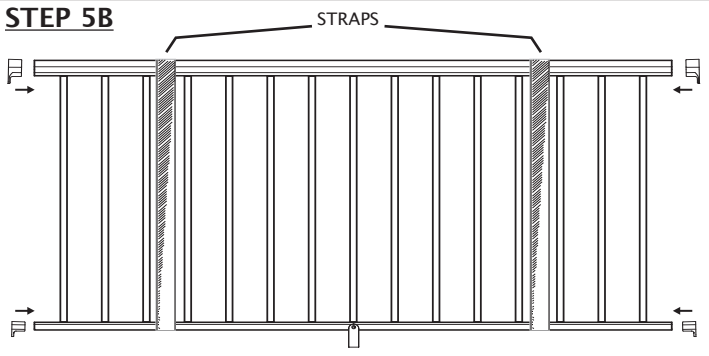

Stair Railing

Installation Guide

ALUMINUM
Solutions
BY FAIRWAY
RAIL SYSTEMS

Kit Includes:

- 1 Sculpted Top Rail (with Adjustable Stair Knuckles and Spacers installed)
- 1 Bottom Rail (with Adjustable Stair Knuckles installed)
- 2 Bottom Rail Brackets (PTP/OTP) Stair (with screws)

Balusters:

- 9 Balusters with 4' Kit
- 14 Balusters with 6' Kit
- 18 Balusters with 8' Kit

Top Rail Brackets sold separately

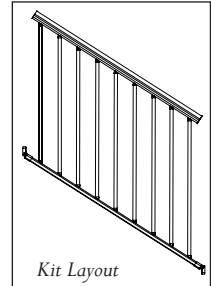

Before Starting the Installation

Review all local building codes. Wear proper safety equipment.

Step 1

Mount & plumb Surface Post Mount. (bolts & shims not included)

Slide sleeve over post mount and check for plumb. (See Step 1 illustration)

Step 2

With post plumb and sleeved, measure distance from post to post. (See Step 2 illustration)

For TOP RAIL - deduct 3-1/4" from measurement.

For BOTTOM RAIL - deduct 2-1/2" from measurement.

NOTE: All measurements apply to stair pitch between 32-38 degrees.

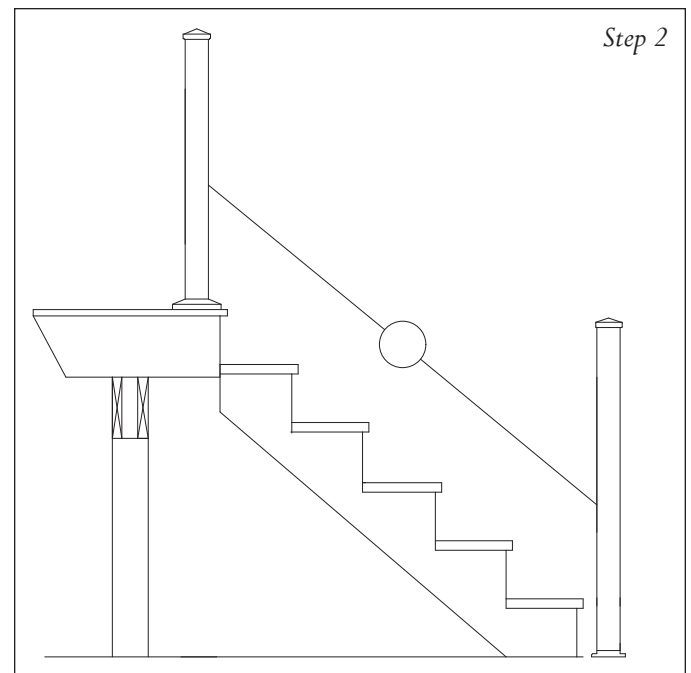
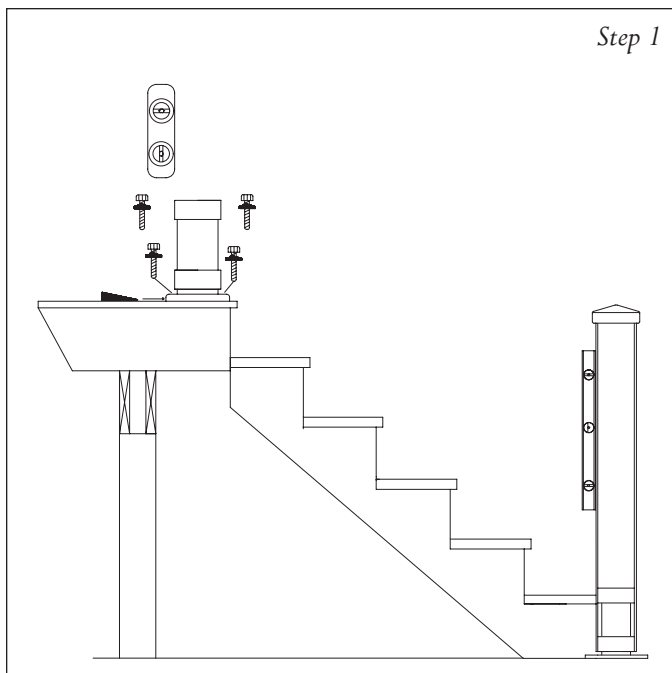

Stair Railing *(continued)*

Installation Guide

Step 3

Remove End Spacers, Mid Spacers, and Adjustable Stair Knuckles from rails.
Cut top and bottom rails to length.

Step 4

Insert Adjustable Stair Knuckles into baluster ends.
Ensure knuckles are facing opposite directions. (See Step 4 illustration)
Slide a baluster (with knuckles) into bottom rail. NOTE: Lay rail on a flat, non-abrasive surface or have a helper assist with keeping components in place.
Slide a Mid Spacer into bottom rail.
Repeat the process until the bottom rail is full of balusters and mid spacers.
NOTE: Ensure baluster knuckles are facing the same direction.

Step 5

Slide balusters and mid spacers flush to one end of rail. Measure open space on opposite end.
Divide this distance in half to allow for equal spacing.
NOTE: At rail ends, the TOTAL space should be **no greater than 8"** and **no less than 4"**, with **equal and maximum spacing** on both ends.
Mid Spacers may need to be uniformly cut to adjust spacing.
Equally cut both end spacers to fit.
Center balusters and mid spacers on rail.
Install end spacers on rail ends, screws oriented on the rail **ends**.

Step 6

Repeat steps 4 and 5 for top rail, ensuring baluster spacing matches bottom rail.

Step 7

Assemble Stair Brackets. (See step 7 illustration)
Brackets mounted to TOP POST - mounting flanges are oriented UP.
Brackets mounted to BOTTOM POST - mounting flanges are oriented DOWN.
Slide brackets on rail section ends. (**Do not** install set screws yet)
Place complete railing section between posts. NOTE: Blocks can be used under bottom rail brackets to hold section in place.
Install self-tapping screws through brackets into posts.
Make final check of baluster plumb and install set screws through top rail bracket into rail.
Install post caps and post base trim.

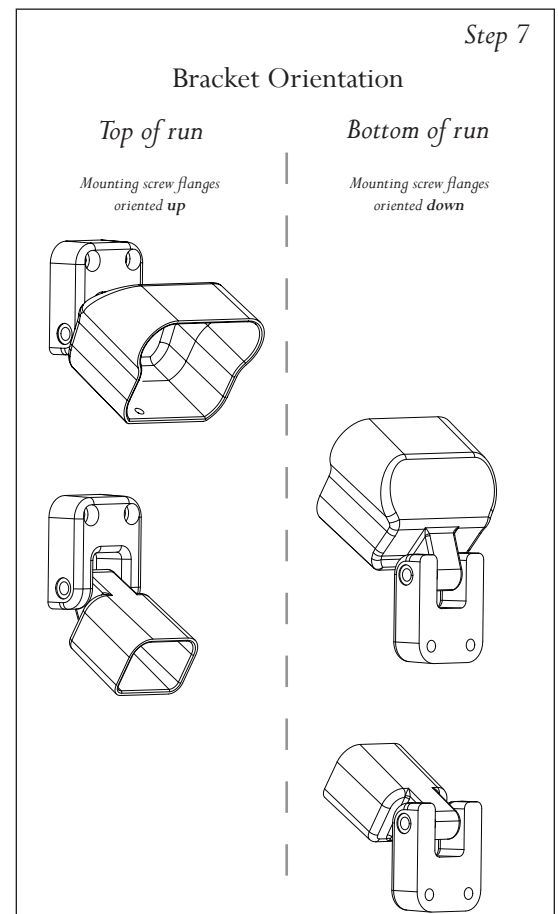
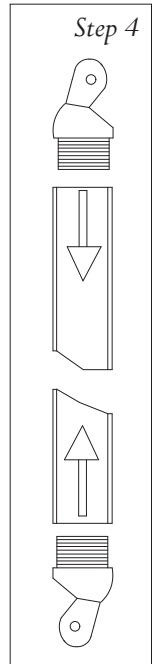

Surface Post Mount

Installation Guide

Surface Post Mount (3-1/2" and 1-7/8")

Before Starting the Installation

Review all local building codes. Wear proper safety equipment.

Step 1

Set post at correct location and mark four mounting holes.

Step 2

Drill for 5/16" mounting bolts. Recommended hole size will vary depending on type of anchor bolt.
(See bolt manufacturer's recommended hole size specifications.)

Step 3

Set post in place with 1/4" stop in line with railing and install bolts (see illustration).
Check post for plumb and shim if necessary (see illustration).

NOTE: Ensure post is mounted to solid blocking when mounted to wood decking.

Specifications

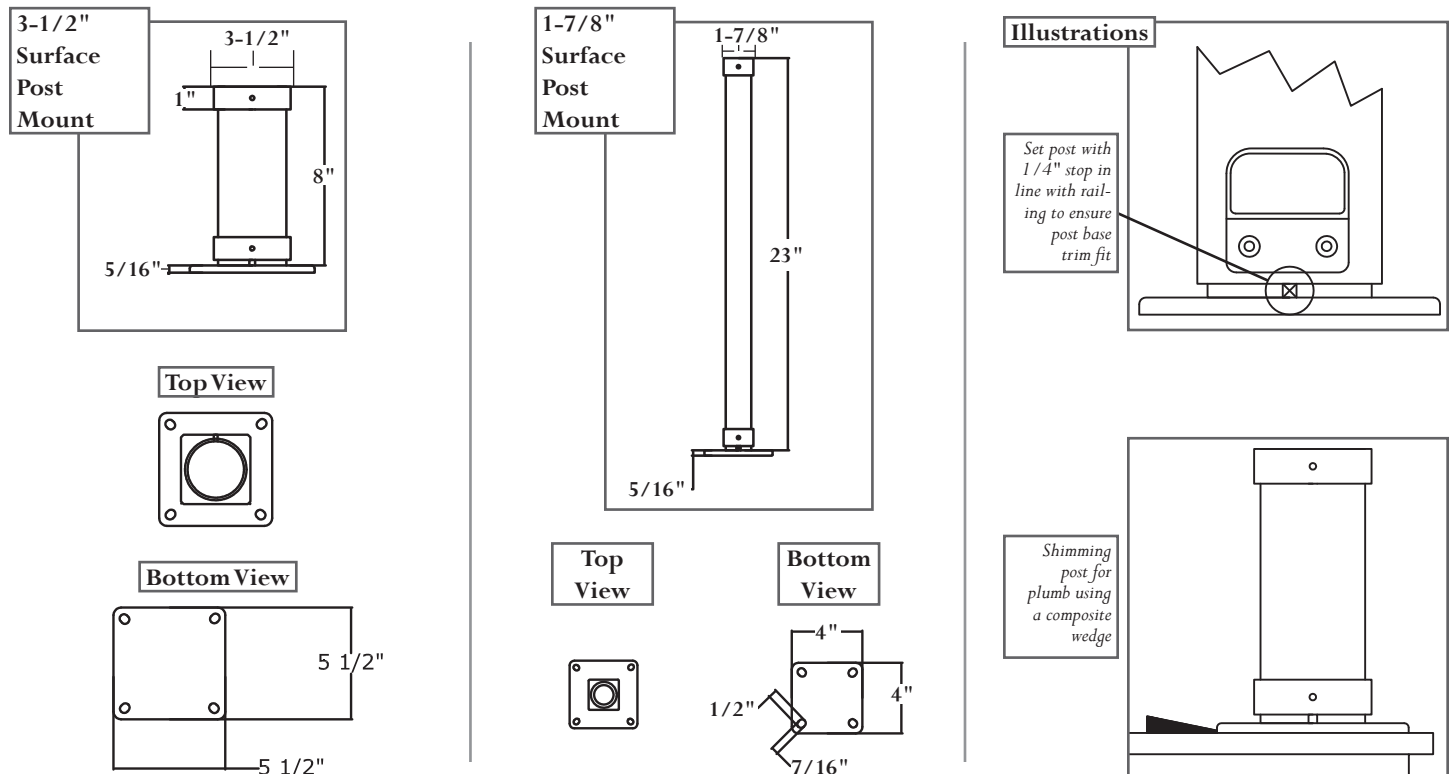

Side/Fascia Post Mount

Installation Guide

ALUMINUM
Solutions
BY FAIRWAY
RAIL SYSTEMS

Before Starting the Installation

Review all local building codes. Wear proper safety equipment.

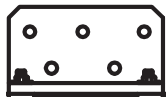

Bracket

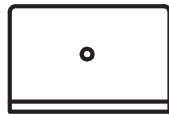

Cover

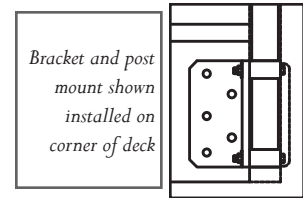

Bracket and post
mount shown
installed on
corner of deck

Corner Post Mount Side/Fascia Bracket

Set corner bracket flush with deck corner. Ensure height is correct, then pre-drill and install five 5/16" mounting bolts. Follow Side/Fascia Post Mount instructions below to mount post to bracket. Finally, install Corner Post Mount Side/Fascia Bracket Cover.

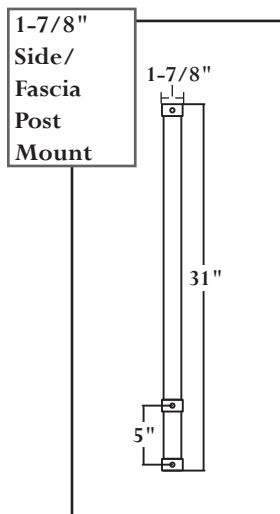

1-7/8"
Side/
Fascia
Post
Mount

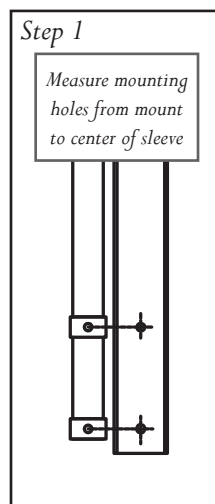

Step 1

Measure mounting
holes from mount
to center of sleeve

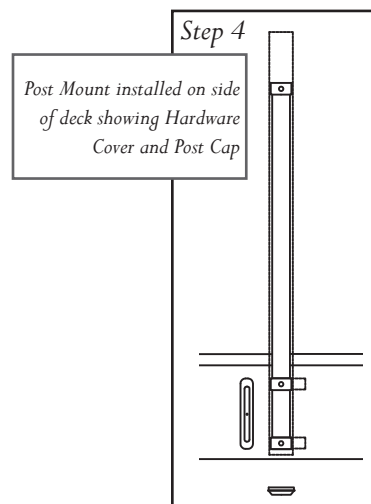

Step 4

Post Mount installed on side
of deck showing Hardware
Cover and Post Cap

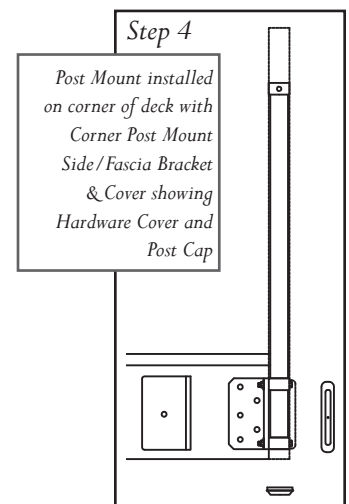

Step 4

Post Mount installed
on corner of deck with
Corner Post Mount
Side/Fascia Bracket
& Cover showing
Hardware Cover and
Post Cap

Side/Fascia Post Mount (1-7/8")

Step 1

Lay post mount on a flat, non-abrasive surface. Lay post sleeve adjacent to post leaving 3/4" of sleeve beyond bottom end of post mount (allowing room for bottom post cap installation). Mark and drill two 7/16" mounting bolt holes on sleeve. Slide sleeve over post mount, aligning mounting bolt holes.

TIP: A 5/16" mounting bolt placed in the bottom hole helps keep post mount and sleeve together when lining up post assembly for installation.

Step 2

Hold post assembly in place where mounting on rim joist. Adjust for correct height and drill **top hole** for 5/16" mounting bolt. (See bolt manufacturer's recommended hole size specifications.)

Remove bottom placeholder mounting bolt, plumb post, and install.

Step 3

Plumb post from **front** to **back**, shimming where necessary between sleeve and rim joist.

Step 4

Install Side/Fascia Post Mount Hardware Cover over mounting bolts. Install 1-7/8" Post Cap by applying silicone adhesive to bottom inside of sleeve and inserting cap.

5° Adjustable Post Mount

Installation Guide

- #1 - Place 5 Degree Adjustable Post Mount in correct location.
Mark four (4) mounting holes.
(1-7/8" or 3-1/2" Surface Mount Post)
- #2 - Drill for 5/16" mounting bolts.
Recommended holes will vary depending on type of anchor bolt.
(see manufacturer recommended size).
- #3 - Secure post.
Check Post For Plumb And Shim If Necessary.

NOTE:
Make certain 5 Degree Adjustable Post Mount is
mounted to solid blocking when mounted to wood decking.

Use Composite
Shims to Plumb Post

